

TAPWARE



DevaTM by METHVEN

No Specific Range

Flow regulator BSM and showers - 7 lpm - Branded Packaging

Product Code: FR106-7

Finish: Plastic

Features

Construction:

Inlet Connections:



*Please refer to website for full warranty details.

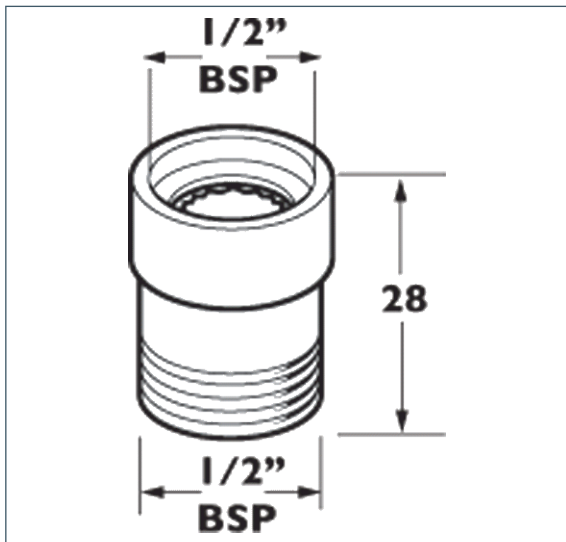

2007800

**1 YEAR
GUARANTEE**

*TERMS APPLY

www.deva.org.uk • FREEPHONE: 0800 195 1602

THE INFORMATION ON THIS SPECIFICATION DOCUMENT WAS CORRECT AT THE DATE OF ISSUE. SOME VARIATION MAY OCCUR DUE TO THE MANUFACTURING TOLERANCES AND SITE SPECIFIC CONDITIONS.